

# Yealink

## T56A-Skype for Business<sup>®</sup> Edition

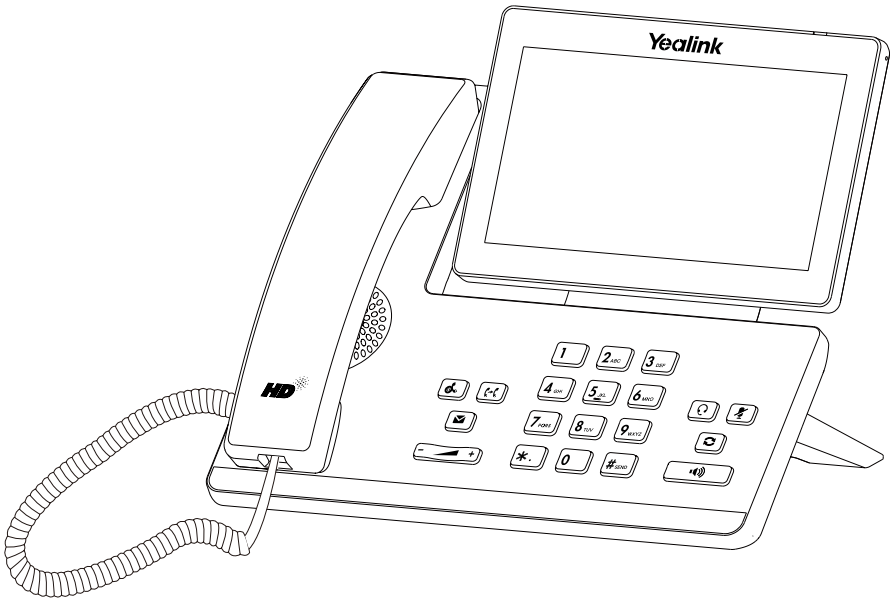

### Quick Start Guide(V9.5)



# Package Contents

The following items are included in your package. If you find anything missing, contact your system administrator.

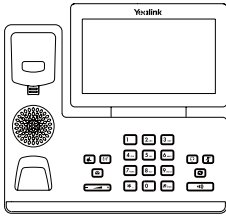

Skype for Business Phone

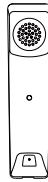

Handset

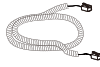

Handset Cord

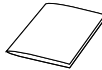

Quick Start Guide



Ethernet Cable  
(2m CAT5E FTP cable)

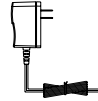

Power Adapter  
( Optional )

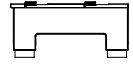

Stand

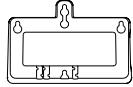

Wallmount Bracket  
( Optional )

**Note:** We recommend that you use the accessories provided or approved by Yealink. The use of unapproved third-party accessories may result in reduced performance.

# Assembling the Phone

**1. Attach the stand, as shown below:**

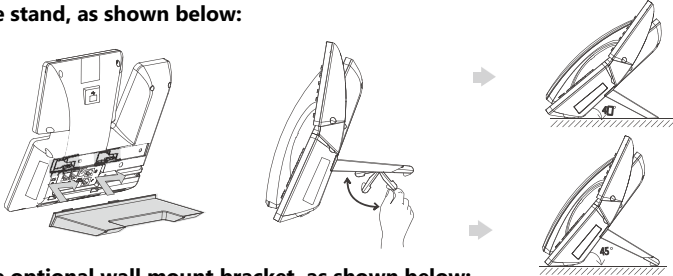

**2. Attach the optional wall mount bracket, as shown below:**

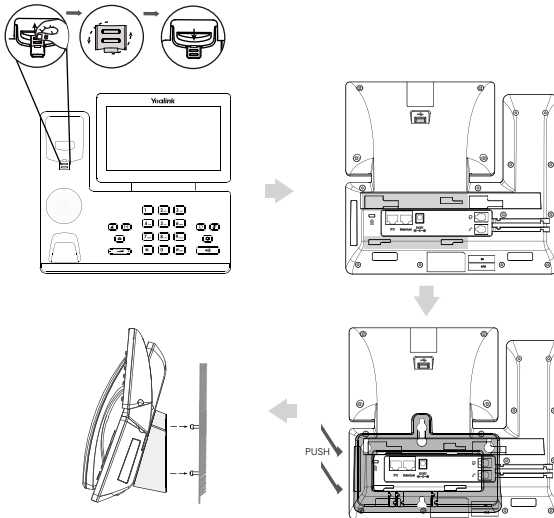

**Note:** The reversible tab has a lip which allows the handset to stay on-hook when the IP phone is mounted vertically. For more information, refer to Yealink Wall Mount Quick Installation Guide for Yealink IP Phones.

### 3. Connect the handset and optional headset, as shown below:

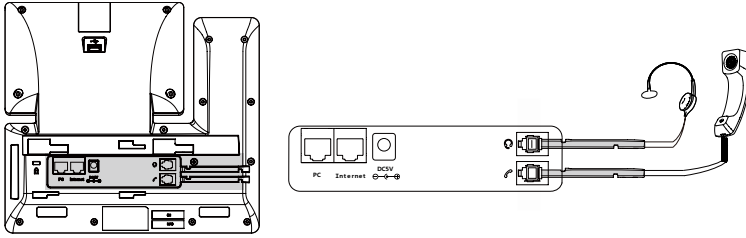

**Note:** The headset should be purchased separately.

### 4. Connect the AC power or PoE, as shown below:

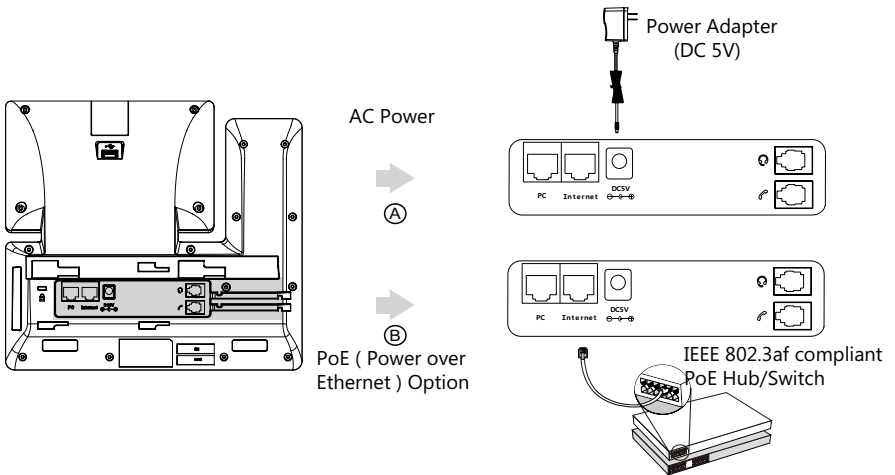

**Note:** The IP phone should be used with Yealink original power adapter (5V/2A) only. The use of the third-party power adapter may damage the phone.

### 5. Connect to the network, as shown below:

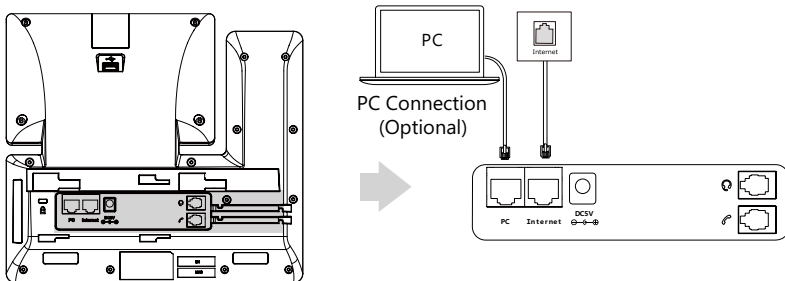

# Hardware Component Instructions

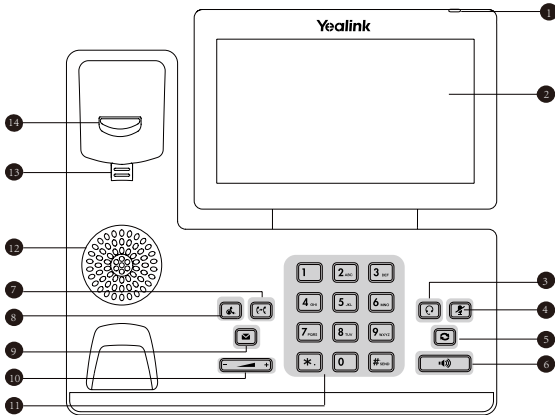

	Item
1	Power LED Indicator
2	Touch Screen
3	HEADSET Key
4	MUTE Key
5	REDIAL Key
6	Speakerphone Key
7	TRANSFER Key
8	HOLD Key
9	MESSAGE Key
10	Volume Key
11	Keypad
12	Speaker
13	Reversible Tab
14	Hookswitch
15	USB2.0 port

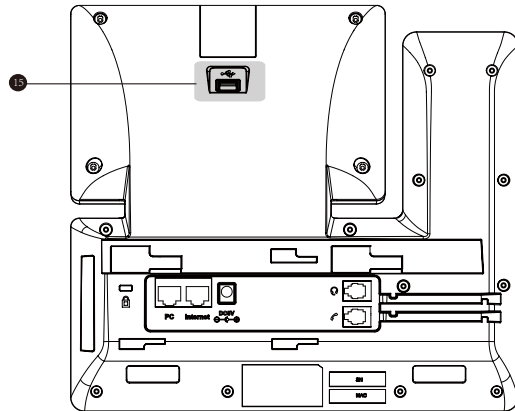

## Startup

After the Skype for Business phone is connected to the network and supplied with power, it automatically begins the initialization process. After startup, the phone enters the sign-in screen.

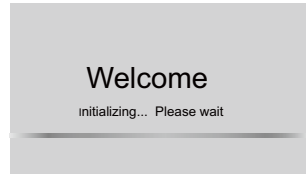

## Sign into or Sign out of Your Skype for Business Account

You can sign into or sign out of your Skype for Business account on the phone.

### To sign into your Skype for Business account:

1. Tap **Sign in**, and then select a desired sign-in method.
2. Follow the on screen prompts.

### To sign out of your Skype for Business account:

1. Tap your avatar at the top-right corner of the touch screen.
2. Tap **Sign Out**.

## Phone Lock

If the phone lock feature is enabled on the Skype for Business server, user can lock the phone to prevent it from unauthorized use.

The Skype for Business phone will prompt the user to create a lock PIN at the initial sign-in.

### To set a lock PIN:

1. Enter the lock PIN in the **New PIN** field.
2. Enter the lock PIN again in the **Confirm PIN** field.
3. Tap **Save** to accept the change.

After you create a lock PIN, you can use it to unlock your phone.

### To unlock the phone:

1. Enter the lock PIN when the phone is locked.
2. Tap **Unlock** to unlock the phone.

## Change Your Presence Status

Your presence information is a quick way for other people to see your availability status. You can change it manually if you want to.

### To update your presence status:

1. Tap your avatar at the top-right corner of the touch screen.
2. Tap the desired status.

## Directory

The phone directory includes local directory and Skype for Business directory.

### To add a local contact:

1. Tap **Contacts**->**Local Directory**->**All**.
2. Tap **Add**.

3. Enter a unique contact name in the **Name** field and other information in the corresponding fields.
4. Tap **Save** to accept the change.

**To add a local favorites:**

1. Tap **Contacts**->**Local Directory**->**Favorite**.
2. Tap **Add**
3. Enter a unique contact name in the **Name** field and other information in the corresponding fields.
4. Select the index number from the pull-down list of **Index**.
5. Tap **Save** to accept the change.

Local favorites display consecutively, according to their index number. The contact with the lowest number displays first. If you select **Null** from the pull-down list of **Index**, the contact displays first.

Contacts with a favorite index number will display .

**To search for contacts:**

1. Pick up the handset, press Speakerphone key or tap .
2. Enter the search criteria.

The phone automatically displays search results.

**To view a contact's information:**

1. Tap **Contacts**.
2. Tap the desired group.
3. Tap the desired contact to view the detailed information.



**To call contacts from the directory:**

1. Tap **Contacts**.
2. Tap the desired group.
3. Tap the desired contact to view the detailed information.
4. Tap .

## Basic Call Features

**To place a call:**



1. Do one of the following:

- Pick up the handset.
- Press .
- Press .

2. Enter the number and then tap **Call**.

**To answer a call:**

1. Do one of the following:

- Pick up the handset. The call is answered in handset mode.
- Press . The call is answered in hands-free (speakerphone) mode.
- Press . The call is answered in headset mode.

**To end a call:**

1. Do one of the following:

- If you are using the handset, hang up the handset or tap **End Call**.
- If you are using the speakerphone, press  or tap **End Call**.
- If you are using the headset, tap **End Call**.

**To redial a call:**

1. Press  when the phone is idle to dial out the last dialed number.

### To mute or un-mute a call:

1. Press  to mute the microphone or press it again to un-mute the microphone during a call.

### To place a call on hold:

1. Press  or tap **Hold** during an active call.

### To resume the held call, do one of the following:

- If there is only one call on hold, press  or tap **Resume**.

- If there is more than one call on hold, tap the call you want to resume, and then press  or tap **Resume**.

### Initiate a Conference Call

You can initiate a Skype for Business conference call by meet now or calling a group of Skype for Business contacts.

#### To initiate a conference call:

1. Tap **Menu**->**Meet Now**-> .

2. Select a contact and tap **Call**.

3. Tap  to add additional contacts.

#### To initiate a conference call within a Skype for Business group:

1. Tap **Contacts**.

2. Tap the desired Skype for Business group.

3. Tap **Dial All** to dial all Skype for Business contacts in this group.

### Call Forward

You can enable the call forward feature to forward all incoming calls to the desired destination.

#### To enable call forward:

1. Tap **Menu**->**Setting**->**Features**->**Call Forward**.

2. Tap the **On** radio box of the **Call Forward** field.

3. Tap the desired type.

4. Tap **Save** to accept the change.

You can also forward an incoming call when your phone is ringing.

#### To forward an incoming call to a contact when your phone is ringing:

1. Tap **Forward**.

2. Select a contact and tap  .

#### To forward an incoming call to voicemail when your phone is ringing:

1. Tap **FWD VM**.

### Call Transfer

You can transfer a call in the following ways:

#### To perform a blind transfer during a call:

1. Press  or tap **Blind Tran** during an active call. The call is placed on hold.

2. Select a contact.

3. Press  or tap **Transfer** to complete the transfer.

Then the call is connected to the number to which you are transferring.

#### To perform a consultative transfer:

1. Tap **Transfer** during an active call. The call is placed on hold.

2. Select a contact and then tap **Call**.

3. After the party answers the call, press  or tap **Transfer** to complete the transfer.



## Using Better Together over Ethernet (BToE)

Better Together over Ethernet (BToE) enables you to place, hold, and answer calls on your phone and Skype for Business client on your computer. You can download the Yealink BToE Connector application from the Yealink Website and install the application on your computer.

Before you can begin using BToE, you must pair your phone with your computer.

### To activate BToE:

1. Do one of the following:

- Connect an Ethernet cable from your computer to the PC port on your phone.
- Enter the phone IP address into the BToE application manually and click OK.

If you are not signed into Skype for Business on your phone, a dialog box is displayed on your computer asking for your Skype for Business login credentials.

2. If the dialog box does not display on your computer, tap **Sign in** on your phone and select **Sign in via PC**.

3. Enter your login credentials in the dialog box.

The same user account is signed into both your phone and your Skype for Business client, so that the BToE is activated.



### To place BToE calls, do one of the following:

- Hover your cursor over the avatar of the contact, and then click  in the Skype for Business client.
- Select a contact or enter the phone number, and then tap **Call**.

### To answer BToE calls, do one of the following:

- Click  in the Skype for Business client.
- Tap **Answer** on your phone.

### To hold BToE calls, do one of the following:

- Click  , and then click  in the Skype for Business client.
- Tap **Hold** or press  on your phone.

### To resume a call, do one of the following:

- Click  and then click  in the Skype for Business client.
- Tap **Resume** or press  on your phone.

### To change the audio device during a call in the Skype for Business client:

1. Click  , and then click  to change the audio device.





## About Yealink

Yealink is a global leading provider of enterprise communication and collaboration solutions, offering video conferencing service to worldwide enterprises. Focusing on research and development, Yealink also insists on innovation and creation. With the outstanding technical patents of cloud computing , audio, video and image processing technology, Yealink has built up a panoramic collaboration solution of audio and video conferencing by merging its cloud services with a series of endpoints products. As one of the best providers in more than 140 countries and regions including the US, the UK and Australia, Yealink ranks No.1 in the global market share of SIP phones shipments.

## Technical Support

Visit Yealink WIKI (<http://support.yealink.com/>) for the latest firmware, guides, FAQ, Product documents, and more. For better service, we sincerely recommend you to use Yealink Ticketing system (<https://ticket.yealink.com>) to submit all your technical issues.



T 5 6 A - S F B - E N

YEALINK(XIAMEN) NETWORK TECHNOLOGY CO.,LTD.

Web: [www.yealink.com](http://www.yealink.com)

Addr: 309, 3rd Floor, No.16, Yun Ding North Road, Huli District, Xiamen City, Fujian, P.R. China

Copyright©2018YEALINK(XIAMEN) NETWORK TECHNOLOGY CO.,LTD.All rights reserved.